

SHOTGUN

CATALOG

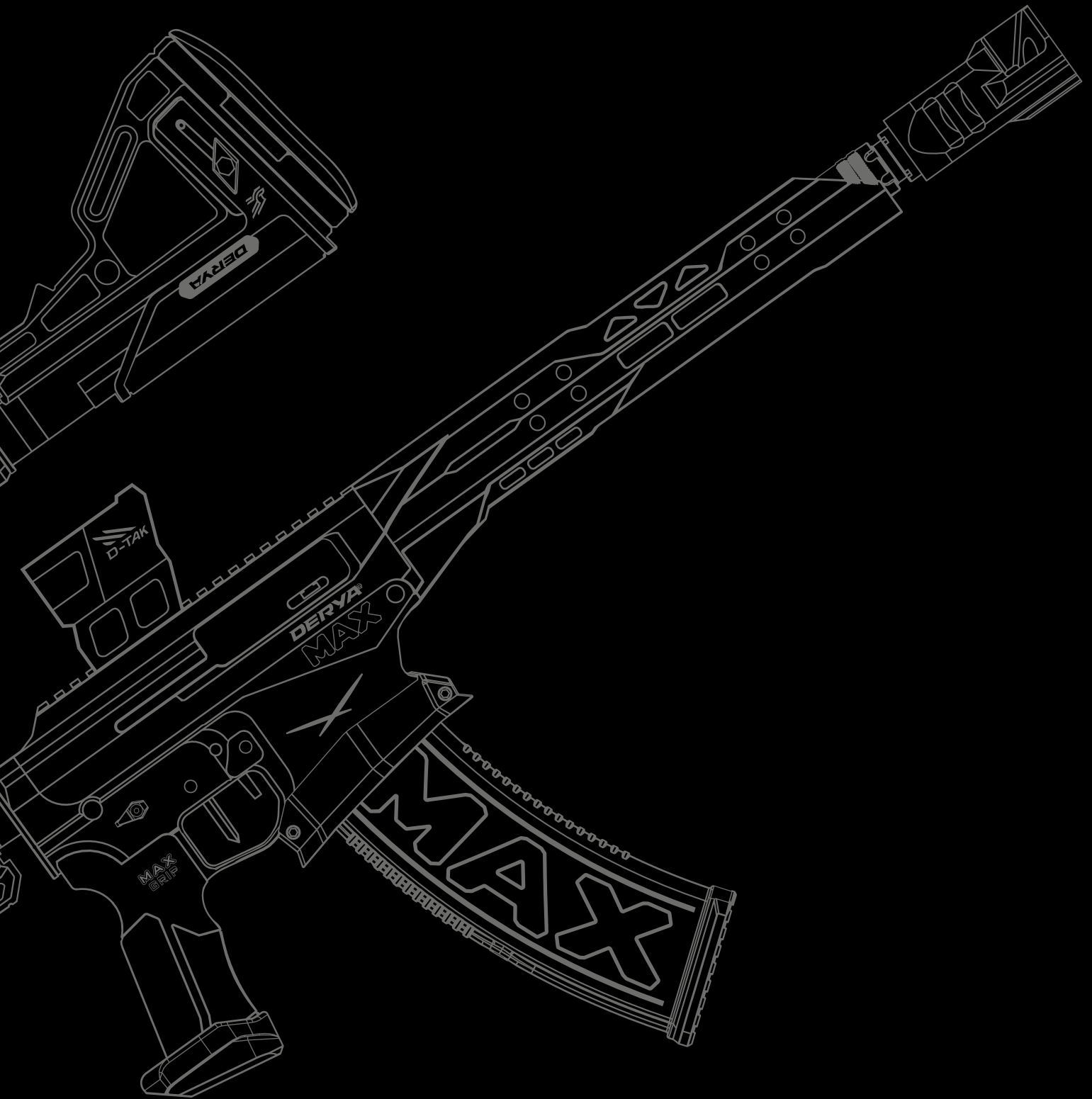

ABOUT US

A Globally Recognized Turkish Firearms Manufacturer

*Founded in **1998** in Konya, Türkiye, **Derya Arms** has grown into one of the leading manufacturers of smoothbore and rifled firearms. With a strong emphasis on R&D, high-precision machining, and international compliance standards (TSE, CIP, SAAMI), we produce reliable, innovative, and performance-driven firearms for tactical, sporting, hunting, and law enforcement purposes. Our headquarters and primary production facility are located in the Beyşehir Organized Industrial Zone, covering a total area of **37,000 m²**.*

*To meet increasing global demand, we've recently completed a new production facility in the Konya Organized Industrial Zone, built on a **40,000 m²** site. With a combined annual capacity of nearly **400,000** units, our operations serve customers in more than **86** countries across all continents. Approximately **90%** of our total production is exported, reflecting our solid position in the international firearms industry.*

*In line with our vision to become a global firearms brand, we've taken strategic steps beyond national borders. In **2024**, we launched our first overseas manufacturing facility in the State of Florida, USA, under the name South Derya Co., and successfully commenced local production. Meanwhile, our **Derya Europe** initiative has been launched with the establishment of a distribution hub in Austria. Once operational, this facility will store CIP-compliant products and significantly improve our delivery times and service capabilities across Europe.*

***Derya Arms** is also a founding partner of Konya Savunma Sanayi A.Ş., a shareholder of ASELSAN Konya Weapon Systems, based in the Konya Technology Industrial Zone. Through such collaborations and global investments, we continue to uphold our commitment to quality, precision, and customer satisfaction while shaping the future of the firearms industry.*



deryaarms.com



NEW PRODUCTS 8-33



TACTICAL 34-91



HUNTING 92-125



SPORT 126-139



CONTENTS

 **DERYA**[®]



6 CONTINENTS

86

APPROVED
DERYA
QUALITY.

COUNTRIES

- ARGENTINA
- AUSTRALIA
- AUSTRIA
- AZERBAIJAN
- ANGOLA
- BANGLADESH
- BELGIUM
- BOTSWANA
- BOSNIA AND HERZEGOVINA
- BRAZIL
- BURKINA FASO
- BULGARIA
- CANADA
- CAMEROON
- CHILE
- COLOMBIA
- CROATIA
- CYPRUS
- CZECH REPUBLIC
- DENMARK
- DOMINICAN REPUBLIC
- ECUADOR
- ENGLAND
- ESTONIA
- FAROE ISLANDS
- FINLAND
- FRENCH GUIANA
- FRANCE
- GHANA
- GEORGIA
- GERMANY
- GREECE
- GUATEMALA
- HUNGARY
- HONG KONG
- INDONESIA
- INDIA
- IRELAND
- ITALY
- JAPAN
- JORDAN
- KAZAKHSTAN
- KOSOVO
- KENYA
- KYRGYZSTAN
- LAO PDR
- LATVIA
- LESOTHO
- LEBANON
- LITHUANIA
- LUXEMBOURG
- MALTA
- MALAYSIA
- MEXICO
- MONTENEGRO
- NAMIBIA
- NETHERLANDS
- NEW CALEDONIA
- NORTH MACEDONIA
- PANAMA
- PAKISTAN
- PARAGUAY
- PERU
- PHILIPPINES
- POLAND
- PORTUGAL
- ROMANIA
- RUSSIA
- SAUDI ARABIA
- SERBIA
- SLOVAKIA
- SLOVENIA
- SRI LANKA
- SOUTH AFRICA
- SPAIN
- SUDAN
- SWEDEN
- SWITZERLAND
- THAILAND
- U.A. EMIRATES
- UKRAINE
- UZBEKISTAN
- UNITED STATES OF AMERICA
- VENEZUELA
- ZIMBABWE
- ZAMBIA

2024

SSI SME EXPORT
CHAMPIONS
GOLD AWARD



2021

GOLDEN BULLSEYE AWARD
VRVP 100 BULLPUP MODEL



2019

MOST SELLING SEMI AUTOMATIC
SHOTGUN IN THE US

MK-12 VR80 MODEL



2018

EXPORT CHAMPIONS OF SHOTGUNS
IN TÜRKİYE



2020/2021

TÜRKİYE BEST EXPORTER LIST

2020-558
2021-728

PROUDLY AWARDED GLOBALLY RESPECTED

RECOGNIZED GLOBALLY FOR EXCELLENCE IN
INNOVATION AND EXPORT PERFORMANCE.



deryaarms.com



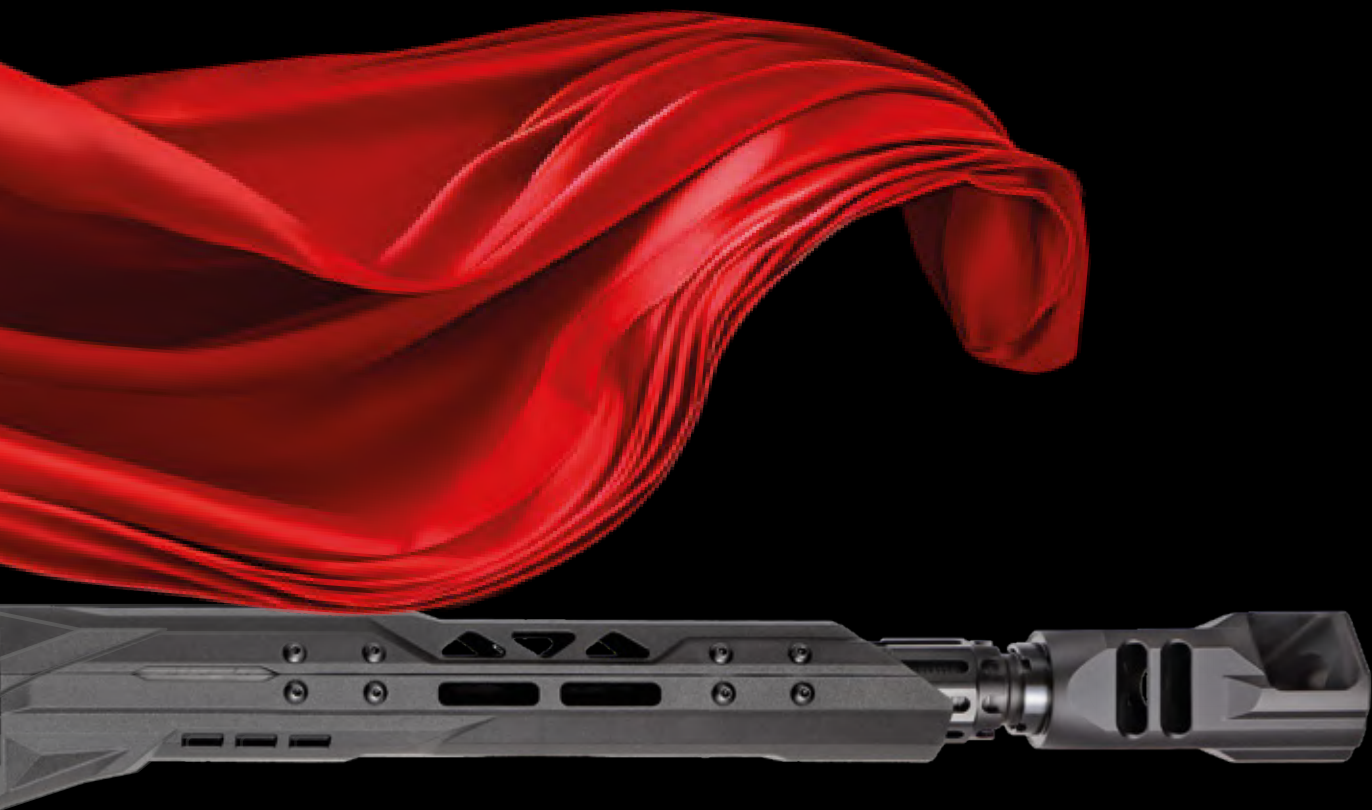

**NEW
PRODUCTS**

DERYA MAX
NEW PRODUCTS / TACTICAL - HUNTING





MAX

The new Derya MAX shotgun was developed in collaboration with top shooters and professional engineers. It combines outstanding reliability, refined ergonomics, and the latest advancements in firearm technology, already proven in World and Continental matches and recognized by elite competitors.

Built for IPSC practical shooting and other dynamic sports, the MAX also comes in a tactical variant ideal for self-defense or personal collections. Its reliability has been proven with tens of thousands of rounds, offering exceptional stability. Thanks to a double-buffered recoil system, progressive muzzle brake, and optimized gas system, firing 28-gram loads feels as light as 24-gram. Even in rapid fire, the muzzle remains steady and

the sights stay on target. Every detail of the MAX follows an adaptive concept, ensuring shooters can tailor the shotgun to their needs. The Grip Lock improves handling and control, while the adaptive stock offers extensive adjustments. Interchangeable muzzle brakes and internal chokes allow fine-tuning of recoil and shot patterns. Optional trigger mechanisms provide a crisp pull, and ambidextrous or 45-degree safeties add versatility.

The ergonomic handguard detaches in seconds for quick access to the gas system and cleaning, while a polymer magwell speeds up reloading. Polymer magazines were specially created for this project, increasing both functionality and reliability. Careful attention to balance shifts the center of mass closer to the shooter, providing undeniable advantages in handling and delivering true MAXimum efficiency.

MAX features



FULLY ADJUSTABLE STOCK WITH 8 POINTS OF ADJUSTMENT



DOUBLE BUFFER SYSTEM



SIGHT WITH ADJUSTMENT OF RETICLE, HEIGHT AND PROTECTION



Adjustable grip support for a stable, secure, and comfortable grip.

ADJUSTABLE PISTOL GRIP PROVIDING ADDITIONAL CONTROL



EXTENDED COMPETITION BOLT RELEASE LEVER AND PERFORMANCE TRIGGER

YOUR MAX PERFORMANCE



**QUICK RELEASE
FOREND FOR FIELD
MAINTENANCE**



**HIGH-PERFORMANCE
MUZZLE BRAKE**



**ERGONOMIC MAGWELL
DESIGN FOR QUICK AND
EASY MAGAZINE CHANGE**

12 Ga. | 50cm / 20" Barrel | 3.50kg Weight* | Semi Automatic

* Weight varies by configuration

DERYA MAX FULL BOX CONTENTS



Includes four chokes;
Modified (***) pre-installed

Includes two backstraps;
Medium backstrap pre-installed.

2x

4x



F-350I



F-410I



F-500I

MODEL	CODE	CALIBER	CHAMBER	CAPACITY	BARREL	WEIGHT	OVERALL	ACTION	CHOKES/MUZZLE DEVICES
DERYA MAX	F-350I	12 gauge	2 ^{3/4} " & 3"	5+1, 10+1	35 cm / 14"	4,28 kg	91 cm	Semi Automatic	MC-5 Choke Set/Compensator
DERYA MAX	F-410I	12 gauge	2 ^{3/4} " & 3"	5+1, 10+1	41 cm / 16"	4,31 kg	95 cm	Semi Automatic	MC-5 Choke Set/Compensator
DERYA MAX	F-500I	12 gauge	2 ^{3/4} " & 3"	5+1, 10+1	50 cm / 20"	4,44 kg	105 cm	Semi Automatic	MC-5 Choke Set/Compensator

MAX BRAKE COMPENSATOR COMES WITH ONLY FULL MODEL

DERYA MAX
NEW PRODUCTS / TACTICAL - SPORT



F-3503



F-4103



F-5003

MODEL	CODE	CALIBER	CHAMBER	CAPACITY	BARREL	WEIGHT	OVERALL	ACTION	CHOKES/MUZZLE DEVICES
DERYA MAX	F-3503	12 gauge	2 ^{3/4} " & 3"	5+1, 10+1	35 cm / 14"	4,28 kg	91 cm	Semi Automatic	MC-5 Choke Set/Compensator
DERYA MAX	F-4103	12 gauge	2 ^{3/4} " & 3"	5+1, 10+1	41 cm / 16"	4,31 kg	95 cm	Semi Automatic	MC-5 Choke Set/Compensator
DERYA MAX	F-5003	12 gauge	2 ^{3/4} " & 3"	5+1, 10+1	50 cm / 20"	4,44 kg	105 cm	Semi Automatic	MC-5 Choke Set/Compensator

MAX BRAKE COMPENSATOR COMES WITH ONLY FULL MODEL



F-3510



F-4110



F-5010

MODEL	CODE	CALIBER	CHAMBER	CAPACITY	BARREL	WEIGHT	OVERALL	ACTION	CHOKES/MUZZLE DEVICES
DERYA MAX	F-3510	12 gauge	2 ^{3/4} " & 3"	5+1, 10+1	35 cm / 14"	4,28 kg	91 cm	Semi Automatic	MC-5 Choke Set/Compensator
DERYA MAX	F-4110	12 gauge	2 ^{3/4} " & 3"	5+1, 10+1	41 cm / 16"	4,31 kg	95 cm	Semi Automatic	MC-5 Choke Set/Compensator
DERYA MAX	F-5010	12 gauge	2 ^{3/4} " & 3"	5+1, 10+1	50 cm / 20"	4,44 kg	105 cm	Semi Automatic	MC-5 Choke Set/Compensator

MAX BRAKE COMPENSATOR COMES WITH ONLY FULL MODEL

DERYA MAX
NEW PRODUCTS / TACTICAL - SPORT



F-3511



F-4111



F-5011

MODEL	CODE	CALIBER	CHAMBER	CAPACITY	BARREL	WEIGHT	OVERALL	ACTION	CHOKES/MUZZLE DEVICES
DERYA MAX	F-3511	12 gauge	2 ^{3/4} " & 3"	5+1, 10+1	35 cm / 14"	4,28 kg	91 cm	Semi Automatic	MC-5 Choke Set/Compensator
DERYA MAX	F-4111	12 gauge	2 ^{3/4} " & 3"	5+1, 10+1	41 cm / 16"	4,31 kg	95 cm	Semi Automatic	MC-5 Choke Set/Compensator
DERYA MAX	F-5011	12 gauge	2 ^{3/4} " & 3"	5+1, 10+1	50 cm / 20"	4,44 kg	105 cm	Semi Automatic	MC-5 Choke Set/Compensator

MAX BRAKE COMPENSATOR COMES WITH ONLY FULL MODEL



F-3522



F-4122



F-5022

MODEL	CODE	CALIBER	CHAMBER	CAPACITY	BARREL	WEIGHT	OVERALL	ACTION	CHOKES/MUZZLE DEVICES
DERYA MAX	F-3522	12 gauge	2 ^{3/4} " & 3"	5+1, 10+1	35 cm / 14"	4,28 kg	91 cm	Semi Automatic	MC-5 Choke Set/Compensator
DERYA MAX	F-4122F	12 gauge	2 ^{3/4} " & 3"	5+1, 10+1	41 cm / 16"	4,31 kg	95 cm	Semi Automatic	MC-5 Choke Set/Compensator
DERYA MAX	F-5022F	12 gauge	2 ^{3/4} " & 3"	5+1, 10+1	50 cm / 20"	4,44 kg	105 cm	Semi Automatic	MC-5 Choke Set/Compensator

MAX BRAKE COMPENSATOR COMES WITH ONLY FULL MODEL

DERYA MAX BASIC BOX CONTENTS



Includes two chokes;
Modified (***) pre-installed



Includes two backstraps;
Medium backstrap pre-installed.

1x



1x





B-350I



B-410I



B-500I

MODEL	CODE	CALIBER	CHAMBER	CAPACITY	BARREL	WEIGHT	OVERALL	ACTION	CHOKES/MUZZLE DEVICES
DERYA MAX	B-350I	12 gauge	2 ^{3/4} " & 3"	5+1, 10+1	35 cm / 14"	3,85 kg	91 cm	Semi Automatic	MC-5 Choke Set/Compensator
DERYA MAX	B-410I	12 gauge	2 ^{3/4} " & 3"	5+1, 10+1	41 cm / 16"	3,95 kg	95 cm	Semi Automatic	MC-5 Choke Set/Compensator
DERYA MAX	B-500I	12 gauge	2 ^{3/4} " & 3"	5+1, 10+1	50 cm / 20"	4,08 kg	105 cm	Semi Automatic	MC-5 Choke Set/Compensator

MAX TAC COMPENSATOR COMES WITH ONLY BASIC MODEL

The new generation Derya CRYX pump-action shotgun stands out with both its visual aesthetics and superior performance. The combination of a premium walnut stock and an M-LOK compatible forend unites traditional elegance with contemporary design.

The 4140 drilled steel barrel, offers superior strength and performance, while its integrated compensator ports minimize recoil and muzzle climb, ensuring maximum control.

With a 6+1 capacity, 7000-series aluminium receiver, and its unique design, the Derya CRYX is an outstanding choice for both collectors and performance enthusiasts alike.

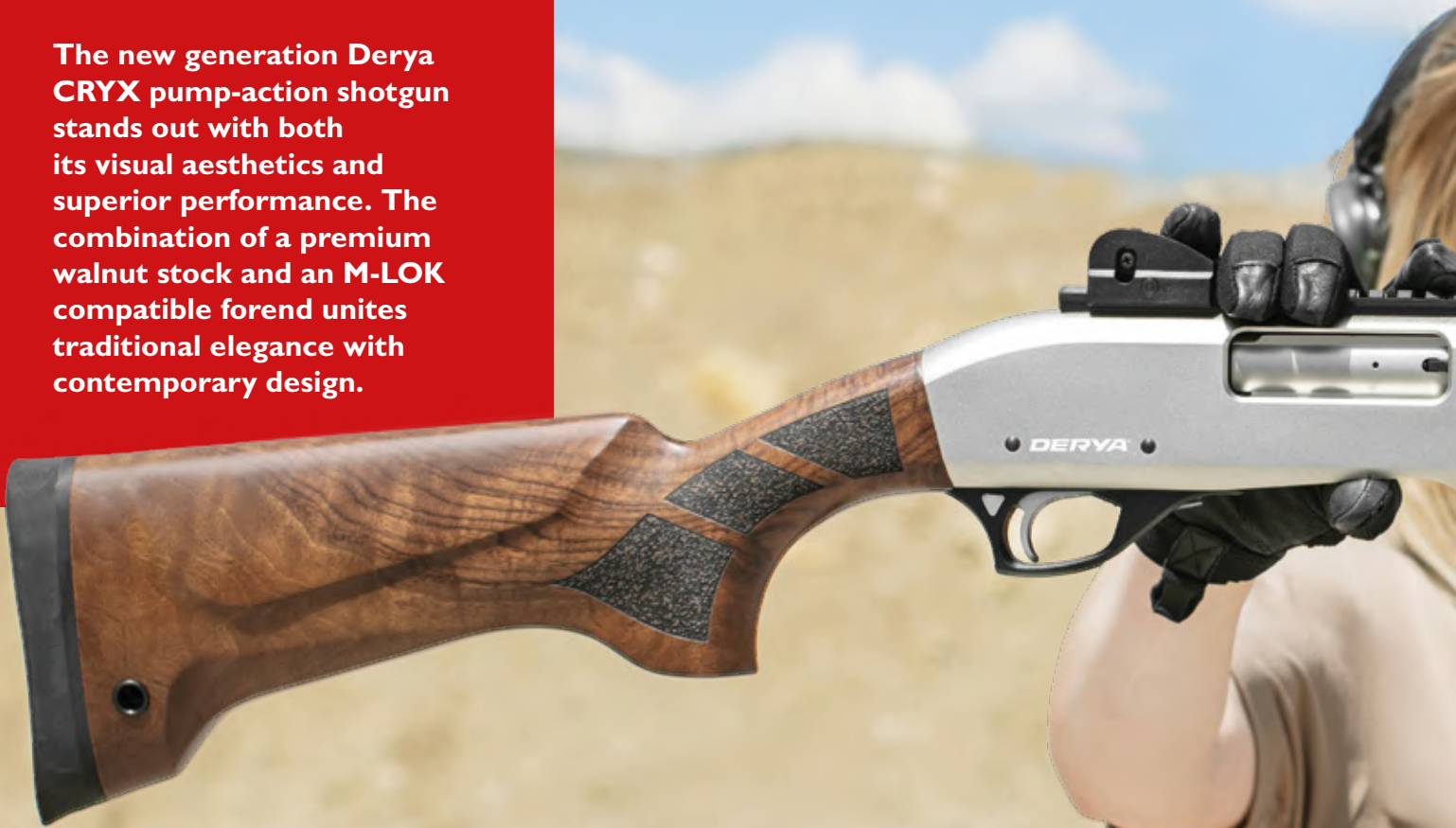



CARINA CRYX features

THE INTERS



DOOR BREACHER



ENLARGED LOADING PORT



4-ROUND SIDE SADDLE



SECTION OF



MODERN & CLASSIC ELEGANCE

12 Ga. | 47cm / 18.5" Barrel | 3.10kg Weight | Pump Action

PORTED BARREL



TURKISH WALNUT
BUTTSTOCK & FOREND



QUICK-DETACH SLING SWIVEL



**CRYX01****CRYX02****CRYX03**

MODEL	CODE	CALIBER	CHAMBER	CAPACITY	BARREL	WEIGHT	OVERALL	ACTION	CHOKES/MUZZLE DEVICES
CARINA	CRYX01	12 gauge	2 ^{3/4} " & 3"	6+1	47 cm / 18.5"	3,10 kg	100 cm	Pump Action	Slug/Flash Hider
CARINA	CRYX02	12 gauge	2 ^{3/4} " & 3"	6+1	47 cm / 18.5"	3,10 kg	100 cm	Pump Action	Slug/Flash Hider
CARINA	CRYX03	12 gauge	2 ^{3/4} " & 3"	6+1	47 cm / 18.5"	3,10 kg	100 cm	Pump Action	Slug/Flash Hider



CRYX11



CRYX12

MODEL	CODE	CALIBER	CHAMBER	CAPACITY	BARREL	WEIGHT	OVERALL	ACTION	CHOKES/MUZZLE DEVICES
CARINA	CRYX11	12 gauge	2 ^{3/4} " & 3"	6+1	47 cm / 18.5"	3,10 kg	100 cm	Pump Action	Slug/Flash Hider
CARINA	CRYX12	12 gauge	2 ^{3/4} " & 3"	6+1	47 cm / 18.5"	3,10 kg	100 cm	Pump Action	Slug/Flash Hider





In the hunting field, those who stand apart are the ones who choose their firearm wisely, not by chance. The Derya Lion Series brings advanced engineering, master-crafted materials, and refined design together in a single, purpose-built platform.

The Derya Lion Series is designed to deliver reliability, balance, and adaptability across a wide range of hunting conditions. Combining traditional craftsmanship with modern engineering, the series reflects Derya's commitment to performance and durability in the field.

Premium walnut stocks and forends emphasize both aesthetics and ergonomics, while lightweight aluminum receivers contribute to fast handling and reduced fatigue. Precision-drilled steel barrels ensure long-term reliability and consistent performance. Equipped with a mobile choke system, the Lion Series

allows hunters to adapt pattern and range to different game and environments. From waterfowl to upland birds and varied hunting terrains, the series is built to respond confidently to changing conditions. Feel the power, balance, and versatility of hunting with Derya.

LION features

MAKE A



HIGH-GRADE ALUMINUM RECEIVER



**TURKISH WALNUT
TEXTURED BUTTSTOCK**



DIFFERENCE



IN THE HUNT

12 Ga. | 71cm / 28" Barrel | 3.20kg Weight | Semi Automatic

INTERCHANGEABLE CHOKE & BEAD SIGHT



VENT-RIB BARREL &
TURKISH WALNUT
TEXTURED FOREARM

E12-101

E20-101

MODEL	CODE	CALIBER	CHAMBER	CAPACITY	BARREL	WEIGHT	OVERALL	ACTION	CHOKES/MUZZLE DEVICES
LION	E12-101	12 gauge	2 ³ / ₄ " & 3"	4+1	71 cm / 28"	3,20 kg	122 cm	Semi Automatic	MC-3 Choke Set
LION	E20-101	20 gauge	2 ³ / ₄ " & 3"	4+1	71 cm / 28"	2,82 kg	122 cm	Semi Automatic	MC-3 Choke Set





E410-101



MODEL	CODE	CALIBER	CHAMBER	CAPACITY	BARREL	WEIGHT	OVERALL	ACTION	CHOKES/MUZZLE DEVICES
LION	E410-101	.410 gauge	2 ^{3/4} " & 3"	4+1	71 cm / 28"	2,75 kg	122 cm	Semi Automatic	MC-3 Choke Set







TACTICAL ZONE

BULLPUP

Our Bullpup model was designed in such a way as to ensure the safety of you and your loved ones. Thanks to the 7075-aluminium upper receiver and polymer design, you have a light, aesthetic, and safe friend.

Thanks to its 74cm total length, 3 kg weight, and compact size, it can be used by all family members and create a secure haven in your house.

With the enclosed 3x2cm butt stock extensions, you can increase the length to 80 cm and adjust your grip position. You can attach your accessories with the 22mm rail, which is also included in the box.

With even the largest magazine installed, it is possible to comfortably hold the Bullpup on target with only the shooting hand.





BULLPUP features

PROTECTO



STOCK EXTENSIONS



ADJUSTABLE CHEEK PAD



R OF YOUR LOVED ONES



12 Ga. | 50cm / 20" Barrel | 3.45kg Weight | Semi Automatic

EJECTOR COVER



FLIP UP SIGHTS



ADDITIONAL PICATINNY RAIL



GRIP OPTIONS AVAILABLE



N-100

MODEL	CODE	CALIBER	CHAMBER	CAPACITY	BARREL	WEIGHT	OVERALL	ACTION	CHOKES/MUZZLE DEVICES
BULLPUP	N-100	12 gauge	2 ^{3/4} " & 3"	2+1, 5+1, 10+1	50 cm / 20"	3,45 kg	80 cm	Semi Automatic	MC-3 Choke Set

**DERYA BULLPUP
TACTICAL**



Derya Bullpup model won the 2021 **Golden Bullseye Award**, given by the firearms magazine of the USA, **American Rifleman**.



DERYA BULLPUP
TACTICAL

MK-12

The Derya MK-12 represents the highest standard in modern 12-gauge semi-automatic shotguns. Designed for demanding users, it has become one of the most recognized and proven platforms in its class, trusted worldwide for its balance, consistency, and dependability.

The MK-12 features an upper and lower receiver precisely machined from 7000 series aluminium, providing exceptional durability while maintaining an optimal weight for control and stability. Its AR-style ergonomics offer a natural and confident handling experience, ensuring accuracy and comfort in every shot. The gas-operated action guarantees reliable cycling with both 2¾" and 3" shells, even in the most challenging environments.

Available with multiple magazine options, the MK-12 is equally suited for tactical, sport, and professional applications. Each shotgun is supplied in a suede carry case with a choke set, QD sling, foregrip, and disassembly tool every component designed with the same attention to detail as the firearm itself.

Respected by shooters around the world for its reliability, precision, and refined construction, the MK-12 stands as Derya's flagship 12-gauge platform, a trusted choice built to perform without compromise.





MK-12 features

THE MK.



ADJUSTABLE STOCK & CHEEK PAD



MAGAZINE OPTIONS AVAILABLE





12 Ga. | 50cm / 20" Barrel | 3.50kg Weight | Semi Automatic

**AMBIDEXTROUS
CHARGING HANDLE**



**FOREND WITH
PICATINNY RAIL & M-LOK**





AS-101S

Our Derya VR80 model was awarded the 2019 Golden Bullseye Award, given by the firearms magazine of the USA, American Hunter



MODEL	CODE	CALIBER	CHAMBER	CAPACITY	BARREL	WEIGHT	OVERALL	ACTION	CHOKES/MUZZLE DEVICES
MK-12	AS-101S	12 gauge	2 ^{3/4} " & 3"	2+1, 5+1, 10+1	50 cm / 20"	3,50 kg	102 cm	Semi Automatic	MC-3 Choke Set



DERYA MK-12
TACTICAL - HUNTING



12 Gauge Drum Magazine For All Derya Mag-Fed Shotguns. 21-Round Capacity



**DERYA MK-12
TACTICAL - HUNTING**



AS-I02SF



AS-I02S

AVAILABLE COLOURS

01	02	03	04	09	10	11	14	16	20	22	23	24
GRAPHITE BLACK	BURNT BRONZE	O.D. GREEN	USMC RED	STORMTROOPER WHITE	TUNGSTEN	FLAT DARK EARTH	GOLD	BLUE TITANIUM	PINK	BLACK CHERRY	BARRET BROWN	MIDNIGHT BRONZE

**AS-I03SF****AS-I03S**

MODEL	CODE	CALIBER	CHAMBER	CAPACITY	BARREL	WEIGHT	OVERALL	ACTION	CHOKES/MUZZLE DEVICES
MK-12	AS-102SF	12 gauge	2 ^{3/4} " & 3"	2+1, 5+1, 10+1	50 cm / 20"	3,50 kg	102 cm	Semi Automatic	MC-3 Choke Set
MK-12	AS-102S	12 gauge	2 ^{3/4} " & 3"	2+1, 5+1, 10+1	50 cm / 20"	3,50 kg	102 cm	Semi Automatic	MC-3 Choke Set
MK-12	AS-103SF	12 gauge	2 ^{3/4} " & 3"	2+1, 5+1, 10+1	50 cm / 20"	3,50 kg	102 cm	Semi Automatic	MC-3 Choke Set
MK-12	AS-103S	12 gauge	2 ^{3/4} " & 3"	2+1, 5+1, 10+1	50 cm / 20"	3,50 kg	102 cm	Semi Automatic	MC-3 Choke Set

**AS-104SF****AS-104S****AS-110SF****AS-110S**

MODEL	CODE	CALIBER	CHAMBER	CAPACITY	BARREL	WEIGHT	OVERALL	ACTION	CHOKES/MUZZLE DEVICES
MK-12	AS-104SF	12 gauge	2 ^{3/4} " & 3"	2+1, 5+1, 10+1	50 cm / 20"	3,50 kg	102 cm	Semi Automatic	MC-3 Choke Set
MK-12	AS-104S	12 gauge	2 ^{3/4} " & 3"	2+1, 5+1, 10+1	50 cm / 20"	3,50 kg	102 cm	Semi Automatic	MC-3 Choke Set
MK-12	AS-110SF	12 gauge	2 ^{3/4} " & 3"	2+1, 5+1, 10+1	50 cm / 20"	3,50 kg	102 cm	Semi Automatic	MC-3 Choke Set
MK-12	AS-110S	12 gauge	2 ^{3/4} " & 3"	2+1, 5+1, 10+1	50 cm / 20"	3,50 kg	102 cm	Semi Automatic	MC-3 Choke Set

**AS-I03GP****AS-I04TP****AS-I54K****AS-I55K**

MODEL	CODE	CALIBER	CHAMBER	CAPACITY	BARREL	WEIGHT	OVERALL	ACTION	CHOKES/MUZZLE DEVICES
MK-12	AS-I03GP	12 gauge	2 ^{3/4} " & 3"	2+1, 5+1, 10+1	50 cm / 20"	3,50 kg	102 cm	Semi Automatic	MC-3 Choke Set
MK-12	AS-I04TP	12 gauge	2 ^{3/4} " & 3"	2+1, 5+1, 10+1	50 cm / 20"	3,50 kg	102 cm	Semi Automatic	MC-3 Choke Set
MK-12	AS-I54K	12 gauge	2 ^{3/4} " & 3"	2+1, 5+1, 10+1	50 cm / 20"	3,50 kg	102 cm	Semi Automatic	MC-3 Choke Set
MK-12	AS-I55K	12 gauge	2 ^{3/4} " & 3"	2+1, 5+1, 10+1	50 cm / 20"	3,50 kg	102 cm	Semi Automatic	MC-3 Choke Set





**AS-101H ULTRA****AS-101Z ULTRA****AS-111M ULTIMATE**

MODEL	CODE	CALIBER	CHAMBER	CAPACITY	BARREL	WEIGHT	OVERALL	ACTION	CHOKES/MUZZLE DEVICES
MK-12	AS-101H ULTRA	12 gauge	2 ^{3/4} " & 3"	2+1, 5+1, 10+1	50 cm / 20"	3,50 kg	102 cm	Semi Automatic	MC-3 Choke Set
MK-12	AS-101Z ULTRA	12 gauge	2 ^{3/4} " & 3"	2+1, 5+1, 10+1	50 cm / 20"	3,50 kg	102 cm	Semi Automatic	MC-3 Choke Set
MK-12	AS-111M ULTIMATE	12 gauge	2 ^{3/4} " & 3"	2+1, 5+1, 10+1	50 cm / 20"	4,25 kg	102 cm	Semi Automatic	MC-3 Choke Set

**AS-109H ULTRA****AS-110H ULTRA****AS-111H ULTRA PRO**

MODEL	CODE	CALIBER	CHAMBER	CAPACITY	BARREL	WEIGHT	OVERALL	ACTION	CHOKES/MUZZLE DEVICES
MK-12	AS-109H ULTRA	12 gauge	2 ^{3/4} " & 3"	2+1, 5+1, 10+1	50 cm / 20"	3,50 kg	102 cm	Semi Automatic	MC-3 Choke Set
MK-12	AS-110H ULTRA	12 gauge	2 ^{3/4} " & 3"	2+1, 5+1, 10+1	50 cm / 20"	3,50 kg	102 cm	Semi Automatic	MC-3 Choke Set
MK-12	AS-111H ULTRA PRO	12 gauge	2 ^{3/4} " & 3"	2+1, 5+1, 10+1	50 cm / 20"	4,10 kg	102 cm	Semi Automatic	MC-3 Choke Set



AS-240

24cm / 9.5" Barrel



AS-350

35cm / 14" Barrel



AS-430

43cm / 17" Barrel

**AS-500****AS-600**

MODEL	CODE	CALIBER	CHAMBER	CAPACITY	BARREL	WEIGHT	OVERALL	ACTION	CHOKES/MUZZLE DEVICES
MK-12	AS-240	12 gauge	2 ^{3/4} " & 3"	2+1, 5+1, 10+1	24 cm / 9.5"	3,00 kg	76 cm	Semi Automatic	MC-3 Choke Set
MK-12	AS-350	12 gauge	2 ^{3/4} " & 3"	2+1, 5+1, 10+1	35 cm / 14"	3,20 kg	87 cm	Semi Automatic	MC-3 Choke Set
MK-12	AS-430	12 gauge	2 ^{3/4} " & 3"	2+1, 5+1, 10+1	43 cm / 17"	3,30 kg	95 cm	Semi Automatic	MC-3 Choke Set
MK-12	AS-500	12 gauge	2 ^{3/4} " & 3"	2+1, 5+1, 10+1	50 cm / 20"	3,40 kg	102 cm	Semi Automatic	MC-3 Choke Set
MK-12	AS-600	12 gauge	2 ^{3/4} " & 3"	2+1, 5+1, 10+1	61 cm / 24"	3,50 kg	113 cm	Semi Automatic	MC-3 Choke Set/Door Breacher



V-101S

MODEL	CODE	CALIBER	CHAMBER	CAPACITY	BARREL	WEIGHT	OVERALL	ACTION	CHOKES/MUZZLE DEVICES
VR70	V-101S	12 gauge	2 ^{3/4} " & 3"	2+1, 5+1, 10+1	50 cm / 20"	3,15 kg	102 cm	Semi Automatic	MC-3 Choke Set



**V-101**

MODEL	CODE	CALIBER	CHAMBER	CAPACITY	BARREL	WEIGHT	OVERALL	ACTION	CHOKES/MUZZLE DEVICES
VR70	V-101	12 gauge	2 ^{3/4} " & 3"	2+1, 5+1, 10+1	50 cm / 20"	3,10 kg	102 cm	Semi Automatic	MC-3 Choke Set

* Compatible with most of the MK-12 accessories.



SO EASY TO USE FOR LEFT HANDED



MODEL	CODE	CALIBER	CHAMBER	CAPACITY	BARREL	WEIGHT	OVERALL	ACTION	CHOKES/MUZZLE DEVICES
MK-12	AS-101LH	12 gauge	2 ^{3/4} " & 3"	2+1, 5+1, 10+1	50 cm / 20"	3,50 kg	102 cm	Semi Automatic	MC-3 Choke Set



DERYA MK-12
TACTICAL - HUNTING



AS-101LH

Double-sided Magazine Release



DERYA MK-12
TACTICAL - HUNTING

**ES-101S**

MODEL	CODE	CALIBER	CHAMBER	CAPACITY	BARREL	WEIGHT	OVERALL	ACTION	CHOKES/MUZZLE DEVICES
MK-20	ES-101S	20 gauge	2 ^{3/4} " & 3"	2+1, 5+1, 10+1	47 cm / 18.5"	3,20 kg	99 cm	Semi Automatic	MC-3 Choke Set



DERYA MK-20
TACTICAL - HUNTING



Compatible with most of the MK-12 accessories and colors.



DERYA MK-20
TACTICAL - HUNTING

LION X

The Lion X-Celerate stands as a resilient and efficient 12-gauge shotgun. With its compact design, exceptional durability, and cost-effective engineering, it unquestionably ranks as the most proficient shotgun in its category.

It lies in a Lion's soul to be strong. To ensure lossless power, you should get to know our superior LION models. With its actions, you will always feel strong and safe.

It is designed to withstand scratches with its specially developed coating for maximum durability. You will dominate and control the power with various stock options that can be folded right and left. Your best friend is always there for you!



LION X features

THE



STOCK OPTIONS AVAILABLE



FIBER OPTIC SIGHT



LION



X-CCELERATE

12 Ga. | 61cm / 24" Barrel | 3.20kg Weight | Semi Automatic

PICATINNY RAIL



ADJUSTABLE SIGHT



**X-301****X-401****X-801****X-802**

MODEL	CODE	CALIBER	CHAMBER	CAPACITY	BARREL	WEIGHT	OVERALL	ACTION	CHOKES/MUZZLE DEVICES
LION X	X-301	12 gauge	2 ^{3/4} " & 3"	8+1	61 cm / 24"	3,20 kg	119 cm	Semi Automatic	MC-3 Choke Set
LION X	X-401	12 gauge	2 ^{3/4} " & 3"	5+1	47 cm / 18.5"	3,00 kg	99 cm	Semi Automatic	MC-3 Choke Set
LION X	X-801	12 gauge	2 ^{3/4} " & 3"	4+1	35 cm / 14"	2,85 kg	90 cm	Semi Automatic	MC-3 Choke Set/Flash Hider
LION X	X-802	12 gauge	2 ^{3/4} " & 3"	4+1	35 cm / 14"	2,85 kg	90 cm	Semi Automatic	MC-3 Choke Set/Flash Hider



MODEL	CODE	CALIBER	CHAMBER	CAPACITY	BARREL	WEIGHT	OVERALL	ACTION	CHOKES/MUZZLE DEVICES
LION X	X-101	12 gauge	2 ^{3/4} " & 3"	4+1	35 cm / 14"	2,90 kg	93 cm	Semi Automatic	Slug/Flash Hider
LION X	X-101/02	12 gauge	2 ^{3/4} " & 3"	4+1	35 cm / 14"	2,90 kg	93 cm	Semi Automatic	Slug/Flash Hider
LION X	X-101/04	12 gauge	2 ^{3/4} " & 3"	4+1	35 cm / 14"	2,90 kg	93 cm	Semi Automatic	Slug/Flash Hider

LION XT

The Derya X-Tactical combines durability, lightweight design, and modern ergonomics for tactical and defensive use. Its polymer build ensures easy handling, while all critical components are Cerakote-coated for maximum protection in any condition.

Equipped with a 50 cm barrel featuring a mobile choke system (61 and 71 cm options available) and a 6+1 capacity with a Match Saver, the X-Tactical is versatile in both defense and field use.

The Dual Piston System (Light & Heavy) guarantees reliable cycling with all loads, including magnum cartridges. Ergonomic features such as the curved loading port, oversized charging handle, and ambidextrous controls provide speed and confidence in action.

A fixed front bead sight, 22 mm Picatinny rail, and additional accessory rails enhance aiming and customization. The adjustable cheek riser and textured forend ensure comfort, control, and stability.

Compatible with single- and two-point slings, the X-Tactical offers full flexibility for professionals in any tactical or defensive scenario.





LION XT 401

TACTICAL



SUPER PER

**ADJUSTABLE CHEEK PAD
& BUTT PAD SPACERS**



**7000 SERIES ALUMINUM RECEIVER
& CARTRIDGE CUT-OFF SYSTEM**



SHOOTING



RIOR RFORMANCE

12 Ga. | 47cm / 18,5" Barrel | 3,15kg Weight | Semi Automatic

PICATINNY RAIL



MATCH SAVER &
ENLARGED CHARGING HANDLE



XT-410

XT-411

MODEL	CODE	CALIBER	CHAMBER	CAPACITY	BARREL	WEIGHT	OVERALL	ACTION	CHOKES/MUZZLE DEVICES
LION	XT-410	12 gauge	2 ^{3/4} " & 3"	6+1	47 cm / 18.5"	3,15 kg	98 cm	Semi Automatic	MC-3 Choke Set
LION	XT-411	12 gauge	2 ^{3/4} " & 3"	6+1	47 cm / 18.5"	3,15 kg	98 cm	Semi Automatic	MC-3 Choke Set



XT-410C



XT-411C

MODEL	CODE	CALIBER	CHAMBER	CAPACITY	BARREL	WEIGHT	OVERALL	ACTION	CHOKES/MUZZLE DEVICES
LION	XT-410C	12 gauge	2 ^{3/4} " & 3"	6+1	47 cm / 18.5"	3,15 kg	98 cm	Semi Automatic	MC-3 Choke Set
LION	XT-411C	12 gauge	2 ^{3/4} " & 3"	6+1	47 cm / 18.5"	3,15 kg	98 cm	Semi Automatic	MC-3 Choke Set

CARINA Q

Even though the shotgun is always visibly fitted with a grip, it can still accommodate the stock attachment. Four polymer shell holders are included. It is compact enough to be stored in a vehicle or at the bedside.

One of the main advantages of the Equalizer family is its compact size and the extra shell holder on the left side. A full Picatinny rail on the heat cage, which completely covers the top, will raise your pleasure.

Those who prefer an even stronger and more effective firepower will love the Equalizer with his muzzle break.





CARINA Q features



SMALL POWER

12 Ga. | 35cm / 14" Barrel | 2,65kg Weight | Pump Action

STOCK OPTIONS AVAILABLE



STOCK OPTIONS AVAILABLE

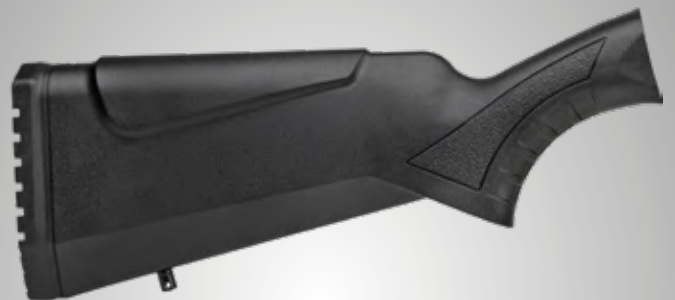

CARINA



L BUT WERFULL

**MUZZLE DEVICE
OPTIONS AVAILABLE**



**CAP OPTIONS
AVAILABLE**

**FULL PICATINNY RAIL
AND SHELL HOLDERS**



**QR-101****QR-102****QR-201****Q-101****Q-103**

MODEL	CODE	CALIBER	CHAMBER	CAPACITY	BARREL	WEIGHT	OVERALL	ACTION	CHOKES/MUZZLE DEVICES
CARINA Q	QR-101	12 gauge	2 ^{3/4} " & 3"	4+1	35 cm / 14"	2,80 kg	70 cm	Pump Action	MC-3 Choke Set/Flash Hider
CARINA Q	QR-102	12 gauge	2 ^{3/4} " & 3"	4+1	35 cm / 14"	2,80 kg	70 cm	Pump Action	MC-3 Choke Set/Flash Hider
CARINA Q	QR-201	12 gauge	2 ^{3/4} " & 3"	4+1	35 cm / 14"	2,85 kg	72 cm	Pump Action	MC-3 Choke Set/Flash Hider
CARINA Q	Q-101	12 gauge	2 ^{3/4} " & 3"	4+1	35 cm / 14"	2,65 kg	67 cm	Pump Action	MC-3 Choke Set
CARINA Q	Q-103	12 gauge	2 ^{3/4} " & 3"	4+1	35 cm / 14"	2,80 kg	70 cm	Pump Action	MC-3 Choke Set/Flash Hider

**SPX-101****SPX-102****SPX-103****SPX-110**

MODEL	CODE	CALIBER	CHAMBER	CAPACITY	BARREL	WEIGHT	OVERALL	ACTION	CHOKES/MUZZLE DEVICES
CARINA	SPX-101	12 gauge	2 ^{3/4} " & 3"	4+1	35 cm / 14"	2,70 kg	93 cm	Pump Action	Muzzle Break
CARINA	SPX-102	12 gauge	2 ^{3/4} " & 3"	4+1	35 cm / 14"	2,70 kg	93 cm	Pump Action	Muzzle Break
CARINA	SPX-103	12 gauge	2 ^{3/4} " & 3"	4+1	35 cm / 14"	2,70 kg	93 cm	Pump Action	Muzzle Break
CARINA	SPX-110	12 gauge	2 ^{3/4} " & 3"	4+1	35 cm / 14"	2,70 kg	93 cm	Pump Action	Muzzle Break

**CRT-40I****CR-40IS****CR-412S****CX-30I****CRQ-40I**

MODEL	CODE	CALIBER	CHAMBER	CAPACITY	BARREL	WEIGHT	OVERALL	ACTION	CHOKES/MUZZLE DEVICES
CARINA	CRT-40I	12 gauge	2 ^{3/4} " & 3"	6+1	47 cm / 18.5"	3,15 kg	100 cm	Pump Action	MC-3 Choke Set
CARINA	CR-40IS	12 gauge	2 ^{3/4} " & 3"	5+1	47 cm / 18.5"	2,80 kg	100 cm	Pump Action	Slug
CARINA	CR-412S	12 gauge	2 ^{3/4} " & 3"	5+1	47 cm / 18.5"	2,80 kg	100 cm	Pump Action	Slug
CARINA X	CX-30I	12 gauge	2 ^{3/4} " & 3"	8+1	61 cm / 24"	3,00 kg	119 cm	Pump Action	MC-3 Choke Set
CARINA	CRQ-40I	12 gauge	2 ^{3/4} " & 3"	6+1	47 cm / 18.5"	3,20 kg	110 cm	Pump Action	Slug/Muzzle Break

**CR-101L****CR-101****CR-101S****CR-201****STW-201**

MODEL	CODE	CALIBER	CHAMBER	CAPACITY	BARREL	WEIGHT	OVERALL	ACTION	CHOKES/MUZZLE DEVICES
CARINA	CR-101L	12 gauge	2 ^{3/4"} & 3"	5+1	71 cm / 28"	3,00 kg	126 cm	Pump Action	MC-3 Choke Set
CARINA	CR-101	12 gauge	2 ^{3/4"} & 3"	5+1	47 cm / 18.5"	2,70 kg	100 cm	Pump Action	Slug
CARINA	CR-101S	12 gauge	2 ^{3/4"} & 3"	5+1	47 cm / 18.5"	2,70 kg	100 cm	Pump Action	Slug
CARINA	CR-201	12 gauge	2 ^{3/4"} & 3"	7+1	71 cm / 28"	3,10 kg	126 cm	Pump Action	MC-3 Choke Set
CARINA	STW-201	12 gauge	2 ^{3/4"} & 3"	6+1	47 cm / 18.5"	2,90 kg	100 cm	Pump Action	Slug

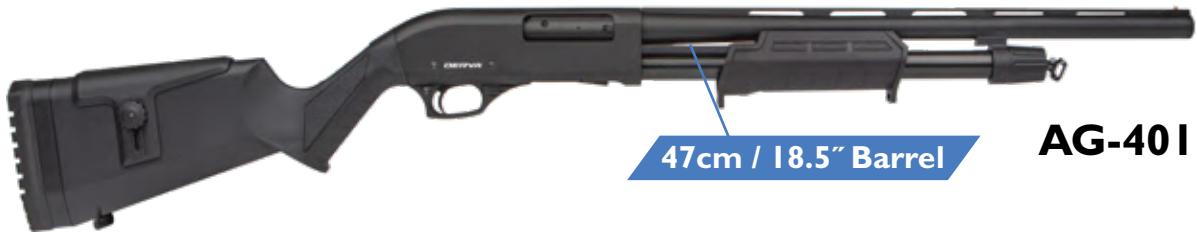
**AG-401****AG12-401**

MODEL	CODE	CALIBER	CHAMBER	CAPACITY	BARREL	WEIGHT	OVERALL	ACTION	CHOKES/MUZZLE DEVICES
CARINA AG	AG-401	12 gauge	2 ^{3/4"} & 3"	5+1	47 cm / 18.5"	3,00 kg	103 cm	Pump Action	MC-3 Choke Set
CARINA AG	AG12-401	12 gauge	2 ^{3/4"} & 3"	5+1	71 cm / 28"	3,10 kg	127 cm	Pump Action	MC-3 Choke Set



DERYA CARINA AG
TACTICAL - HUNTING

**AG20-40I****AG410-40I****AG410-20I**

MODEL	CODE	CALIBER	CHAMBER	CAPACITY	BARREL	WEIGHT	OVERALL	ACTION	CHOKES/MUZZLE DEVICES
CARINA AG	AG20-40I	20 gauge	2 ^{3/4} " & 3"	5+1	66 cm / 26"	3,10 kg	122 cm	Pump Action	MC-3 Choke Set
CARINA AG	AG410-40I	.410 gauge	2 ^{3/4} " & 3"	5+1	66 cm / 26"	3,00 kg	122 cm	Pump Action	MC-3 Choke Set
CARINA AG	AG410-20I	.410 gauge	2 ^{3/4} " & 3"	5+1	47 cm / 18"	2,35 kg	99 cm	Pump Action	MC-3 Choke Set



DERYA CARINA AG
TACTICAL - HUNTING

CARINA VX

An agile 12-gauge magazine-fed shotgun with extensive options to modify range, stability, and maneuverability. The CVX-101 features improved capacity and a “state-of-the-art” design, making it widely used by private security, police forces, and the military.

The CVX-101 comes with high-par damage output and a high rate of fire, making it a decent middle ground for engaging targets at any range while being powerful enough to down defenders.

Shotgun accepts different accessories thanks to its 22mm standard Picatinny rail.



VWX



CARINA VX features

CARINA



EASILY DETACH LOWER FROM UPPER RECEIVER



ADJUSTABLE SIGHT



AVX YOUR PROTECTOR



12 Ga. | 50cm / 20" Barrel | 3.10kg Weight | Pump Action

**ALSO COMPATIBLE
WITH DERYA SERIES MAGAZINES**



HEAT CAGE



**CVX-101****CVX-801**

MODEL	CODE	CALIBER	CHAMBER	CAPACITY	BARREL	WEIGHT	OVERALL	ACTION	CHOKES/MUZZLE DEVICES
CARINA VX	CVX-101	12 gauge	2 ^{3/4} " & 3"	2+1, 5+1, 10+1	50 cm / 20"	3,10 kg	104 cm	Pump Action	MC-3 Choke Set
CARINA VX	CVX-801	12 gauge	2 ^{3/4} " & 3"	2+1, 5+1, 10+1	50 cm / 20"	3,10 kg	104 cm	Pump Action	MC-3 Choke Set

**CVX-401****CVX-612**

MODEL	CODE	CALIBER	CHAMBER	CAPACITY	BARREL	WEIGHT	OVERALL	ACTION	CHOKES/MUZZLE DEVICES
CARINA VX	CVX-401	12 gauge	2 ^{3/4} " & 3"	2+1, 5+1, 10+1	50 cm / 20"	3,10 kg	104 cm	Pump Action	MC-3 Choke Set
CARINA VX	CVX-612	12 gauge	2 ^{3/4} " & 3"	2+1, 5+1, 10+1	50 cm / 20"	3,10 kg	104 cm	Pump Action	MC-3 Choke Set



**HUNTING
ZONE**

LION

This shotgun is effective at most ranges and has a decent rate of fire and accuracy, making it a well-balanced shotgun that is useful for most engagements.

The Wanderer is a semi-automatic shotgun with a recoil-reducing gas-operated system. This shotgun unloads high volumes of lead down range at a steady rate.

This shotgun has a 5+1 ammo capacity for continuous firing. Effective at close and long ranges. A long back-bored barrel and cylindrical choke keep the spread tight and are very effective on extended ranges.

It uses a gas piston operating system in an attempt to improve the reliability of the weapon.





LION features



**TURKISH WALNUT
TEXTURED BUTTSTOCK**



**ELEGANT LASER
ENGRAVED RECEIVER**



DEFER



SELECTION

12 Ga. | 71cm / 28" Barrel | 3.40kg Weight | Semi Automatic

SHELL SELECTION LEVER



VENTILATED RIB WITH BEAD SIGHT



**W-101****W-102****W-104**

MODEL	CODE	CALIBER	CHAMBER	CAPACITY	BARREL	WEIGHT	OVERALL	ACTION	CHOKES/MUZZLE DEVICES
LION	W-101	12 gauge	2 ^{3/4} " & 3"	5+1	71 cm / 28"	3,40 kg	122 cm	Semi Automatic	MC-3 Choke Set
LION	W-102	12 gauge	2 ^{3/4} " & 3"	5+1	71 cm / 28"	3,40 kg	122 cm	Semi Automatic	MC-3 Choke Set
LION	W-104	12 gauge	2 ^{3/4} " & 3"	5+1	71 cm / 28"	3,40 kg	122 cm	Semi Automatic	MC-3 Choke Set



**P-101****P-110****P-112**

MODEL	CODE	CALIBER	CHAMBER	CAPACITY	BARREL	WEIGHT	OVERALL	ACTION	CHOKES/MUZZLE DEVICES
LION	P-101	12 gauge	2 ^{3/4} " & 3"	5+1	71 cm / 28"	3,40 kg	124 cm	Semi Automatic	MC-3 Choke Set
LION	P-110	12 gauge	2 ^{3/4} " & 3"	5+1	71 cm / 28"	3,40 kg	124 cm	Semi Automatic	MC-3 Choke Set
LION	P-112	12 gauge	2 ^{3/4} " & 3"	5+1	71 cm / 28"	3,40 kg	124 cm	Semi Automatic	MC-3 Choke Set





C-100



C-200



C-300

**C-102****C-301**

MODEL	CODE	CALIBER	CHAMBER	CAPACITY	BARREL	WEIGHT	OVERALL	ACTION	CHOKES/MUZZLE DEVICES
LION	C-100	12 gauge	2 ^{3/4} " & 3"	5+1	71 cm / 28"	3,30 kg	124 cm	Semi Automatic	MC-3 Choke Set
LION	C-200	12 gauge	2 ^{3/4} " & 3"	5+1	71 cm / 28"	3,30 kg	124 cm	Semi Automatic	MC-3 Choke Set
LION	C-300	12 gauge	2 ^{3/4} " & 3"	5+1	71 cm / 28"	3,30 kg	124 cm	Semi Automatic	MC-3 Choke Set
LION	C-102	12 gauge	2 ^{3/4} " & 3"	5+1	71 cm / 28"	3,30 kg	124 cm	Semi Automatic	MC-3 Choke Set
LION	C-301	12 gauge	2 ^{3/4} " & 3"	5+1	71 cm / 28"	3,30 kg	124 cm	Semi Automatic	MC-3 Choke Set

MERIVA

The Over & Under is a type of shotgun that features two barrels, with one mounted on top of the other, making it an indispensable hunting shotgun. With its new and unique design, the MERIVA is waiting for all users who have a passion for hunting and want to experience the joy of the hunt. You can enjoy the pleasure of using this Over & Under shotgun with peace of mind and use it for many years.

The Over & Under shotgun is used for clay target sports, hunting waterfowl, in addition to trap and skeet shooting. Double-barrel shotguns are made with a choke design that allows their shot groups to converge at a certain range.

Our shotgun is presented to our users as a 12 gauge and is produced stronger and more durable than its counterparts. It is the perfect combination of aluminium and walnut, which is still accepted all over the world today. It is the meeting point for those who want to touch quality, elegance, and perfection.





MERIVA features

MERIVA



ADJUSTABLE CHEEK PAD



TRAP AND SKEET TOP RAIL



VIA FOR



ANCED USERS

12 Ga. | 76cm / 30" Barrel | 3.80kg Weight | Break Action

HEIGHT ADJUSTMENT OF TOP RAIL

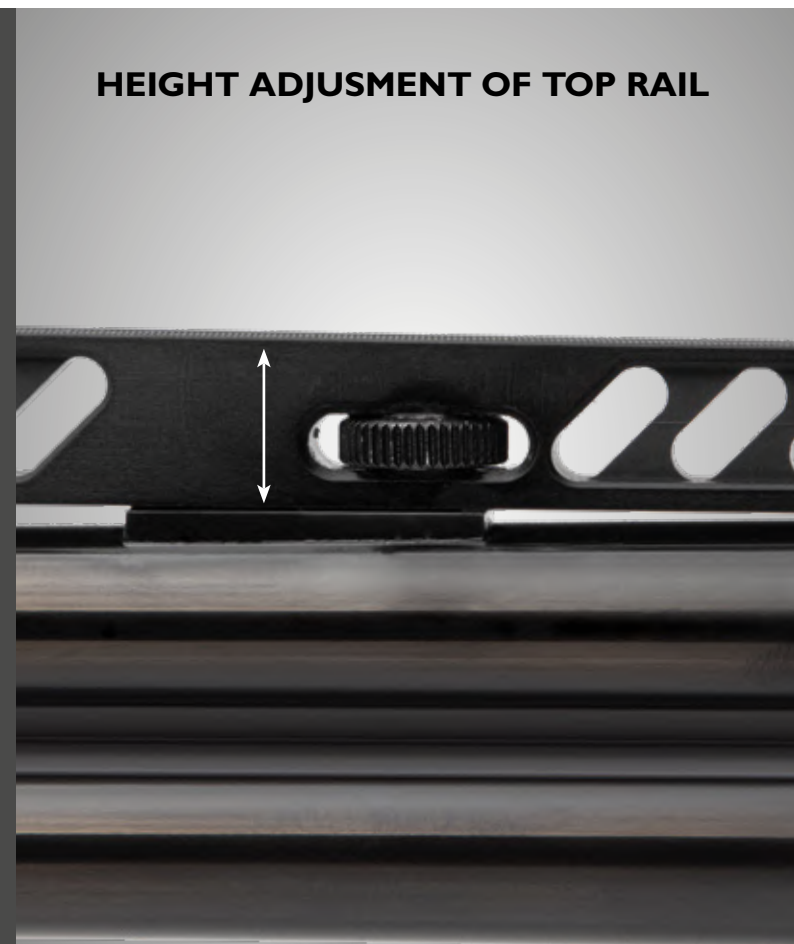

EXTENDED MOBILE CHOKES



**MR-100****MR-200****MR-300**

MODEL	CODE	CALIBER	CHAMBER	CAPACITY	BARREL	WEIGHT	OVERALL	ACTION	CHOKES/MUZZLE DEVICES
MERIVA	MR-100	12 gauge	2 ^{3/4"} & 3"	2	71 cm / 28"	3,30 kg	115 cm	Break Action	MC-3 Choke Set
MERIVA	MR-200	12 gauge	2 ^{3/4"} & 3"	2	71 cm / 28"	3,30 kg	115 cm	Break Action	MC-3 Choke Set
MERIVA	MR-300	12 gauge	2 ^{3/4"} & 3"	2	71 cm / 28"	3,30 kg	115 cm	Break Action	MC-3 Choke Set

**MR-S1****MR-S2**

MODEL	CODE	CALIBER	CHAMBER	CAPACITY	BARREL	WEIGHT	OVERALL	ACTION	CHOKES/MUZZLE DEVICES
MERIVA	MR-S1	12 gauge	2 ^{3/4} " & 3"	2	76 cm / 30"	3,80 kg	120 cm	Break Action	MC-5 Lux Choke Set
MERIVA	MR-S2	12 gauge	2 ^{3/4} " & 3"	2	76 cm / 30"	3,60 kg	120 cm	Break Action	MC-5 Lux Choke Set

MERIVA

For those who look next to our improver product range for classic designs, this Side-by-Side shotgun with a double hammer has been brought to life with Derya quality.

This model, made of polished walnut, is preferred by hunters who favor classic and traditional gun designs.

The barrel is made of 4140 steel and has a length of 61 cm/24". To provide the best resistance in the worst conditions without leaving the classic line, the main parts are made of stainless steel and scratch-resistant steel, and additional safety is added.

Are you ready for the traditional hunting experience with the first pioneer of hunting guns?





MERIVA MC features

PRIMED



CLASSIC DOUBLE HAMMER



PRECISION DOUBLE TRIGGER

FOR THE GREAT ADVENTURE



12 Ga. | 61cm / 24" Barrel | 3.00kg Weight | Break Action

RELIABLE TOP LEVER



TURKISH WALNUT TEXTURED BUTTSTOCK



**MC-101-61****MC-101-50****MC-101-47**

MODEL	CODE	CALIBER	CHAMBER	CAPACITY	BARREL	WEIGHT	OVERALL	ACTION	CHOKES/MUZZLE DEVICES
MERIVA	MC-101-61	12 gauge	2 ^{3/4} " & 3"	2	61 cm / 24"	3,00 kg	98 cm	Break Action	MC-3 Choke Set
MERIVA	MC-101-50	12 gauge	2 ^{3/4} " & 3"	2	50 cm / 20"	2,90 kg	88 cm	Break Action	MC-3 Choke Set
MERIVA	MC-101-47	12 gauge	2 ^{3/4} " & 3"	2	47 cm / 18.5"	2,85 kg	84 cm	Break Action	MC-3 Choke Set

**MC-112D-61****MC-157-61****MC-112-61****MC-121-61**

MODEL	CODE	CALIBER	CHAMBER	CAPACITY	BARREL	WEIGHT	OVERALL	ACTION	CHOKES/MUZZLE DEVICES
MERIVA	MC-112D-61	12 gauge	2 ^{3/4} " & 3"	2	61 cm / 24"	3,00 kg	98 cm	Break Action	MC-3 Choke Set
MERIVA	MC-157-61	12 gauge	2 ^{3/4} " & 3"	2	61 cm / 24"	3,00 kg	98 cm	Break Action	MC-3 Choke Set
MERIVA	MC-112-61	12 gauge	2 ^{3/4} " & 3"	2	61 cm / 24"	3,00 kg	98 cm	Break Action	MC-3 Choke Set
MERIVA	MC-121-61	12 gauge	2 ^{3/4} " & 3"	2	61 cm / 24"	3,00 kg	98 cm	Break Action	MC-3 Choke Set

RUBY RISE

With the revival of a classic product of Derya quality, you will feel like you are living in that time. The receiver and the barrel are machined from steel, while the forend and the stock are made of Turkish walnut.

The Derya Lever action shotgun uses .410ga cartridges and has a side loading gate for easy reloading while in action.

It has the modern safety precaution that you have to completely close the lever to fire the shotgun.

Shoot quickly and effectively with the modern sight equipped with a Picatinny rail and the capacity of 7+1 rounds.

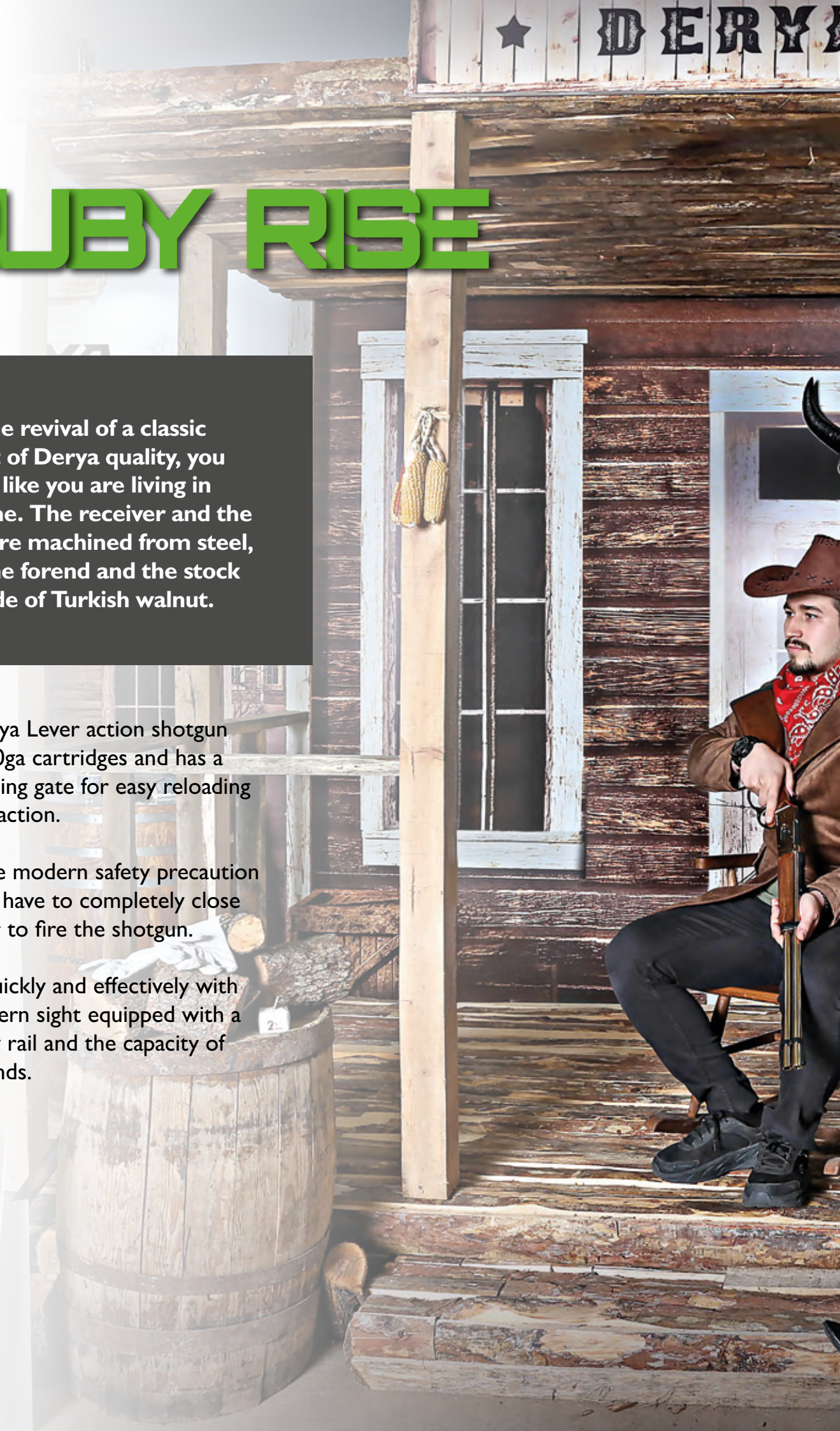

A A R M S ★



RUBY RISE features

THE
OF



**REBOUNDED HAMMER
MECHANISM**



PICATINNY RAIL



CHOICE COWBOYS

.410 Ga. | 50cm / 20" Barrel | 3.00kg Weight | Lever Action

LOADING PORT



**STEEL RECEIVER /
WALNUT FOREND AND STOCK**



**MD-101****MD-112****MD-157****MD-114**

MODEL	CODE	CALIBER	CHAMBER	CAPACITY	BARREL	WEIGHT	OVERALL	ACTION	CHOKES/MUZZLE DEVICES
RUBY RISE	MD-101	.410 gauge	2 ^{3/4} "	7+1	50 cm / 20"	3,00 kg	108 cm	Lever Action	MC-3 Choke Set
RUBY RISE	MD-112	.410 gauge	2 ^{3/4} "	7+1	50 cm / 20"	3,00 kg	108 cm	Lever Action	MC-3 Choke Set
RUBY RISE	MD-157	.410 gauge	2 ^{3/4} "	7+1	50 cm / 20"	3,00 kg	108 cm	Lever Action	MC-3 Choke Set
RUBY RISE	MD-114	.410 gauge	2 ^{3/4} "	7+1	50 cm / 20"	3,00 kg	108 cm	Lever Action	MC-3 Choke Set

**MD-112D****MD-401****MD-412****MD-414**

MODEL	CODE	CALIBER	CHAMBER	CAPACITY	BARREL	WEIGHT	OVERALL	ACTION	CHOKES/MUZZLE DEVICES
RUBY RISE	MD-101	.410 gauge	2 ^{3/4} "	7+1	50 cm / 20"	3,00 kg	108 cm	Lever Action	MC-3 Choke Set
RUBY RISE	MD-401	.410 gauge	2 ^{3/4} "	7+1	50 cm / 20"	2,90 kg	108 cm	Lever Action	MC-3 Choke Set
RUBY RISE	MD-412	.410 gauge	2 ^{3/4} "	7+1	50 cm / 20"	2,90 kg	108 cm	Lever Action	MC-3 Choke Set
RUBY RISE	MD-414	.410 gauge	2 ^{3/4} "	7+1	50 cm / 20"	2,90 kg	108 cm	Lever Action	MC-3 Choke Set

SINGLE EDGE

Your introduction to shooting could have been taught by your parents or maybe grandparents by taking you out in the forest or field and patiently explaining how to shoulder it, how to lean into the gun, how to use that bead, and how to lead on a bird or rabbit.

Single shots were originally made for hunters who needed a reliable, affordable gun, and still have a place among young shooters and folks who harken to a bygone era. This gun is a very popular choice among hunters across the country.

This shotgun comes in 12, 20, and .410 gauges with a slug or choked barrel. It's reliable and great for nostalgic one-shot hunting or as an easy introduction to shooting for new shooters, especially young ones.





SINGLE EDGE features

FIRST



PLAN

RECOIL PAD WITH SPACERS

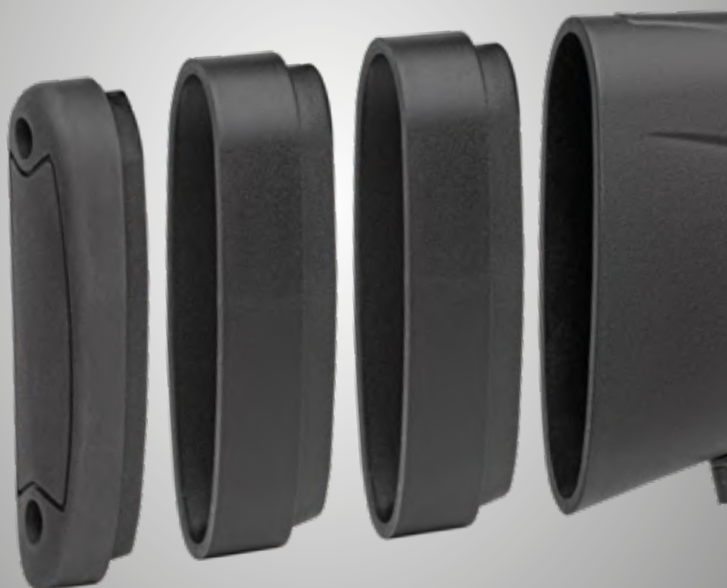

EXTERNAL HAMMER



STEP TO HANDLE A SHOTGUN

12 Ga. | 50cm / 20" Barrel | 2.60kg Weight | Break Action

ADJUSTABLE REAR SIGHT
(PATENTED)



BEAD SIGHT AND RAIL



**SS-103****TK-114****TK-103****TS-103**

MODEL	CODE	CALIBER	CHAMBER	CAPACITY	BARREL	WEIGHT	OVERALL	ACTION	CHOKES/MUZZLE DEVICES
SINGLE EDGE	SS-103	12 gauge	2 ^{3/4} " & 3"	1	50 cm / 20"	2,60 kg	91 cm	Break Action	MC-3 Choke Set
SINGLE EDGE	TK-114	12 gauge	2 ^{3/4} " & 3"	1	50 cm / 20"	2,60 kg	91 cm	Break Action	MC-3 Choke Set
SINGLE EDGE	TK-103	12 gauge	2 ^{3/4} " & 3"	1	50 cm / 20"	2,60 kg	91 cm	Break Action	MC-3 Choke Set
SINGLE EDGE	TS-103	12 gauge	2 ^{3/4} " & 3"	1	50 cm / 20"	2,60 kg	91 cm	Break Action	MC-3 Choke Set

**SS-104****SS-105****SS-TRI**

MODEL	CODE	CALIBER	CHAMBER	CAPACITY	BARREL	WEIGHT	OVERALL	ACTION	CHOKES/MUZZLE DEVICES
SINGLE EDGE	SS-104	.410 gauge	2 ^{3/4} " & 3"	1	50 cm / 20"	2,60 kg	91 cm	Break Action	Slug
SINGLE EDGE	SS-105	20 gauge	2 ^{3/4} " & 3"	1	50 cm / 20"	2,60 kg	91 cm	Break Action	Slug
SINGLE EDGE	SS-TRI	12/20/.410ga.	2 ^{3/4} " & 3"	1	50 cm / 20"	2,60 kg	91 cm	Break Action	MC-3 / Slug





**IPSC OFFICIAL
SPONSOR**

**SPORT
ZONE**

MK12 IPSC

The MK-12 IPSC version is a popular shotgun for IPSC sports and it is second to none. With its five different barrel lengths, forends, accessories, and color options, this MK-12 can be modified just as you want.

The MK-12 IPSC is the result of a partnership between DERYA and the International Practical Shooting Confederation. The IPSC models have been specially developed for shooting sports and offer excellent ergonomics at an outstanding price-performance ratio.

The Magwell and the enlarged magazine release button facilitate quick and smooth reloading. The gas system is engineered for even gas distribution, which means that even lighter loads can be reliably fired. The sporty character is particularly emphasized by some orange-colored elements and the IPSC logo. Show your difference with your shots and modifications.





MK-12 IPSC features



FLAT-FACED PRECISION TRIGGER



EXTENDED MAGAZINE RELEASE



ND IPSC



MADE FOR EACH OTHER

12 Ga. | 61cm / 24" Barrel | 3.50kg Weight | Semi Automatic



FLARED MAGWELL



MULTI PORT COMPENSATOR



IP-240

24cm / 9.5" Barrel



IP-350

35cm / 14" Barrel



IP-430

43cm / 17" Barrel

AVAILABLE COLOURS

- GRAPHITE BLACK
01
- HUNTER ORANGE
05



IP-500



IP-600

MODEL	CODE	CALIBER	CHAMBER	CAPACITY	BARREL	WEIGHT	OVERALL	ACTION	CHOKES/MUZZLE DEVICES
MK-12 IPSC	IP-240	12 gauge	2 ^{3/4} " & 3"	2+1, 5+1, 10+1	24 cm / 9.5"	3,00 kg	76 cm	Semi Automatic	MC-3 Choke Set/Compensator
MK-12 IPSC	IP-350	12 gauge	2 ^{3/4} " & 3"	2+1, 5+1, 10+1	35 cm / 14"	3,20 kg	87 cm	Semi Automatic	MC-3 Choke Set/Compensator
MK-12 IPSC	IP-430	12 gauge	2 ^{3/4} " & 3"	2+1, 5+1, 10+1	43 cm / 17"	3,30 kg	95 cm	Semi Automatic	MC-3 Choke Set/Compensator
MK-12 IPSC	IP-500	12 gauge	2 ^{3/4} " & 3"	2+1, 5+1, 10+1	50 cm / 20"	3,40 kg	102 cm	Semi Automatic	MC-3 Choke Set/Compensator
MK-12 IPSC	IP-600	12 gauge	2 ^{3/4} " & 3"	2+1, 5+1, 10+1	61 cm / 24"	3,50 kg	113 cm	Semi Automatic	MC-3 Choke Set/Compensator

LION PRACTICAL IPSC

Revised and optimized for maximum effectiveness and functionality for IPSC shooting. We are delighted to present the Lion Practical.

The enlarged feed and ejection openings optimize the loading mechanism and guarantee fast handling and maximum performance. The LP series also has a top rail with a lever (elevator system), a barrel length of 61 cm, and a capacity of 9+1, but thanks to the match saver feature, you will have an extra chance to shoot.

The forend has a soft grip with the rubber structure. These shotguns are IPSC certificated thanks to the DERYA-IPSC partnership. There are no other alternatives in the most challenging tournaments.

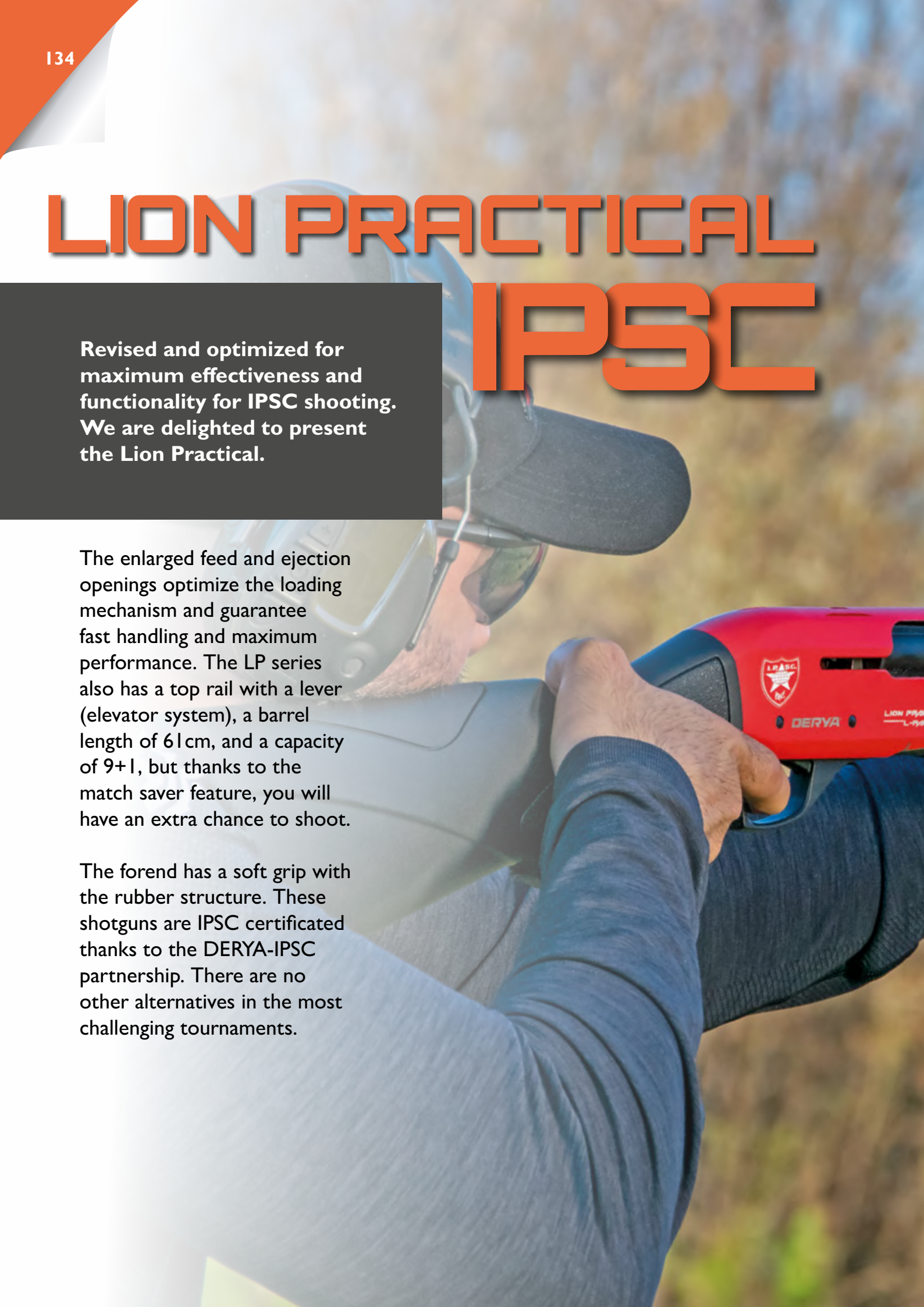



LION PRACTICAL IPSC features



ENLARGED LOADING PORT



AMBIDEXTROUS CHARGING HANDLE



DIPSC



DESIGNED FOR EACH OTHER

12 Ga. | 61cm / 24" Barrel | 3.00kg Weight | Semi Automatic

MATCH SAVER



TOP RAIL & HEIGHT ADJUSTMENT





LP-101



LP-104



LP-105

MODEL	CODE	CALIBER	CHAMBER	CAPACITY	BARREL	WEIGHT	OVERALL	ACTION	CHOKES/MUZZLE DEVICES
LION PRACTICAL	LP-101	12 gauge	2 ^{3/4} " & 3"	9+1	61 cm / 24"	3,00 kg	114 cm	Semi Automatic	MC-3 Choke Set
LION PRACTICAL	LP-104	12 gauge	2 ^{3/4} " & 3"	9+1	61 cm / 24"	3,00 kg	114 cm	Semi Automatic	MC-3 Choke Set
LION PRACTICAL	LP-105	12 gauge	2 ^{3/4} " & 3"	9+1	61 cm / 24"	3,00 kg	114 cm	Semi Automatic	MC-3 Choke Set

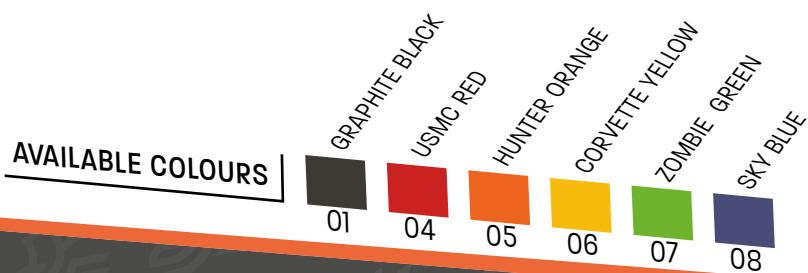

**LP-106****LP-107****LP-108**

MODEL	CODE	CALIBER	CHAMBER	CAPACITY	BARREL	WEIGHT	OVERALL	ACTION	CHOKES/MUZZLE DEVICES
LION PRACTICAL	LP-106	12 gauge	2 ^{3/4} " & 3"	9+1	61 cm / 24"	3,00 kg	114 cm	Semi Automatic	MC-3 Choke Set
LION PRACTICAL	LP-107	12 gauge	2 ^{3/4} " & 3"	9+1	61 cm / 24"	3,00 kg	114 cm	Semi Automatic	MC-3 Choke Set
LION PRACTICAL	LP-108	12 gauge	2 ^{3/4} " & 3"	9+1	61 cm / 24"	3,00 kg	114 cm	Semi Automatic	MC-3 Choke Set



ACCESSORIES

CODE	DESCRIPTION
D020980	D-TAK D02 Reddot



CODE	DESCRIPTION
D020979	D-TAK D01 Reddot



CODE	DESCRIPTION
D050714	Compensator for MK-12 / MAX



CODE	DESCRIPTION
D050715	Compensator for MK-12 / MAX

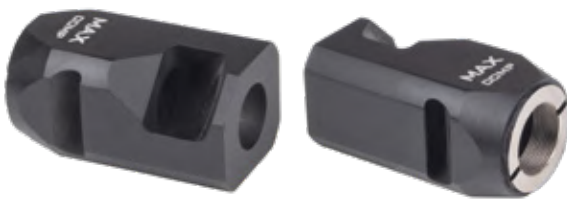

CODE	DESCRIPTION
D050716	Compensator for MK-12 / MAX

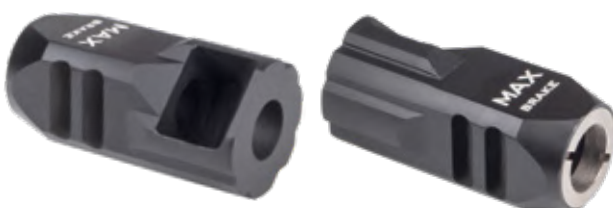

CODE	DESCRIPTION
S12B-506B	Magazine for DERYA MAX

ONLY COMPATIBLE WITH MAX MODELS



CODE	DESCRIPTION
S12B-506C	Magazine for DERYA MAX

ONLY COMPATIBLE WITH MAX MODELS



CODE	DESCRIPTION
S12B-522	DERYA MAX Toolkit



CODE	DESCRIPTION
S12B-509	DERYA MAX Grip Set



CODE	DESCRIPTION
S12B-156	DERYA MAX Grip Support

ONLY COMPATIBLE WITH MAX MODELS



CODE	DESCRIPTION
S12B-740	MAX B.A.D. Lever

ONLY COMPATIBLE WITH MAX MODELS



CODE	DESCRIPTION
S12-517	DERYA MAX Magwell

ONLY COMPATIBLE WITH MAX MODELS





CODE	DESCRIPTION
S12B-670.Y	DERYA MAX Stock Assembly

CODE	DESCRIPTION
S12B-519	Mobile Choke Wrench Tool



CODE	DESCRIPTION
S12B-750	Performance Trigger Assembly



CODE	DESCRIPTION
S12B-45B	Charging Handle



CODE	DESCRIPTION
D020864	Foregrip



CODE	DESCRIPTION
D020141	D-TAK Ballistic Protective Eyewear (Set)



CODE	DESCRIPTION
D012750	12 Ga., Speed Loader



CODE	DESCRIPTION
D020977	Single Point V Sling



CODE	DESCRIPTION
D080016	QD Sling Swivel



CODE	DESCRIPTION
D020981	D-TAK Bipod



CODE	DESCRIPTION
D080073	Aluminium Grip Holes Design



CODE	DESCRIPTION
D010505	Door Breacher (suitable with MK-12)



CODE	DESCRIPTION
D050088	B.A.D. Lever Black
D05008805	Orange color option available



CODE	DESCRIPTION
D050061	Adapter for Compensator (Only for MK-12 produced before 2019)



CODE	DESCRIPTION
D010863	Bolt Stopper



CODE	DESCRIPTION
D010012	Multi Wrench



CODE	DESCRIPTION
D055012	Alu Offset Sight Adapter Set



CODE	DESCRIPTION
D010674	Match Saver for LP Series



CODE	DESCRIPTION
D080070	Large Compensator for MK-12



CODE	DESCRIPTION
D080069	Small Compensator for MK-12



CODE	DESCRIPTION
D080020	Medium Compensator for MK-12



CODE	DESCRIPTION
D080019	Compensator for Bullpup



CODE	DESCRIPTION
D080071	Compensator, MK-20



CODE	DESCRIPTION
D010907	Forend Cover



CODE	DESCRIPTION
D055039	Drum Magazine (21 rounds)



CODE	DESCRIPTION
D080014	Magwell
D080064	MK-20 Magwell
D08001405	Orange color option available



CODE	DESCRIPTION
D055011	Mag Capacity Extender



CODE	DESCRIPTION
D055009	Mag Pouch



CODE	DESCRIPTION
D050006	19 round Magazine (All magazines suitable with MK-12, CVX series, Bullpup, VR series)



CODE	DESCRIPTION
D050005	10 round Magazine



CODE	DESCRIPTION
D050004	5 round Magazine



CODE	DESCRIPTION
D050003	2 round Magazine



CODE	DESCRIPTION
D055017	Mag Pouch Belt



CODE	DESCRIPTION
D080013	QD Sling Mount for MK-12



CODE	DESCRIPTION
D010984	Choke Tube Wrench



CODE	DESCRIPTION
D055010	Extended Mag Release Button for MK-12
D05501005	Orange color option available



CODE	DESCRIPTION
D010761	Carry Handle / Sight



CODE	DESCRIPTION
D010378	Special Trigger for MK-12
D01037805	Orange color option available



CODE	DESCRIPTION
D050057	Flip-up Sight Set



CODE	DESCRIPTION
D010753	Foregrip



CODE	DESCRIPTION
D055008	Mobile Choke Set (F, M, C)



CODE	DESCRIPTION
D050053	Extended Mobile Choke Set (F, M, C)



CODE	DESCRIPTION
D055021	Mobile Choke Set (F, M, C) For 20 Gauge



CODE	DESCRIPTION
D055020	Mobile Choke Set (F, M, C) For .410 Gauge



CODE	DESCRIPTION
D050778	Lux Mobile Choke Set (F, IM, M, IC, C)



SCAN THE QR CODE FOR MORE PRODUCTS





ACTIONS **SPEAK** LOUDER

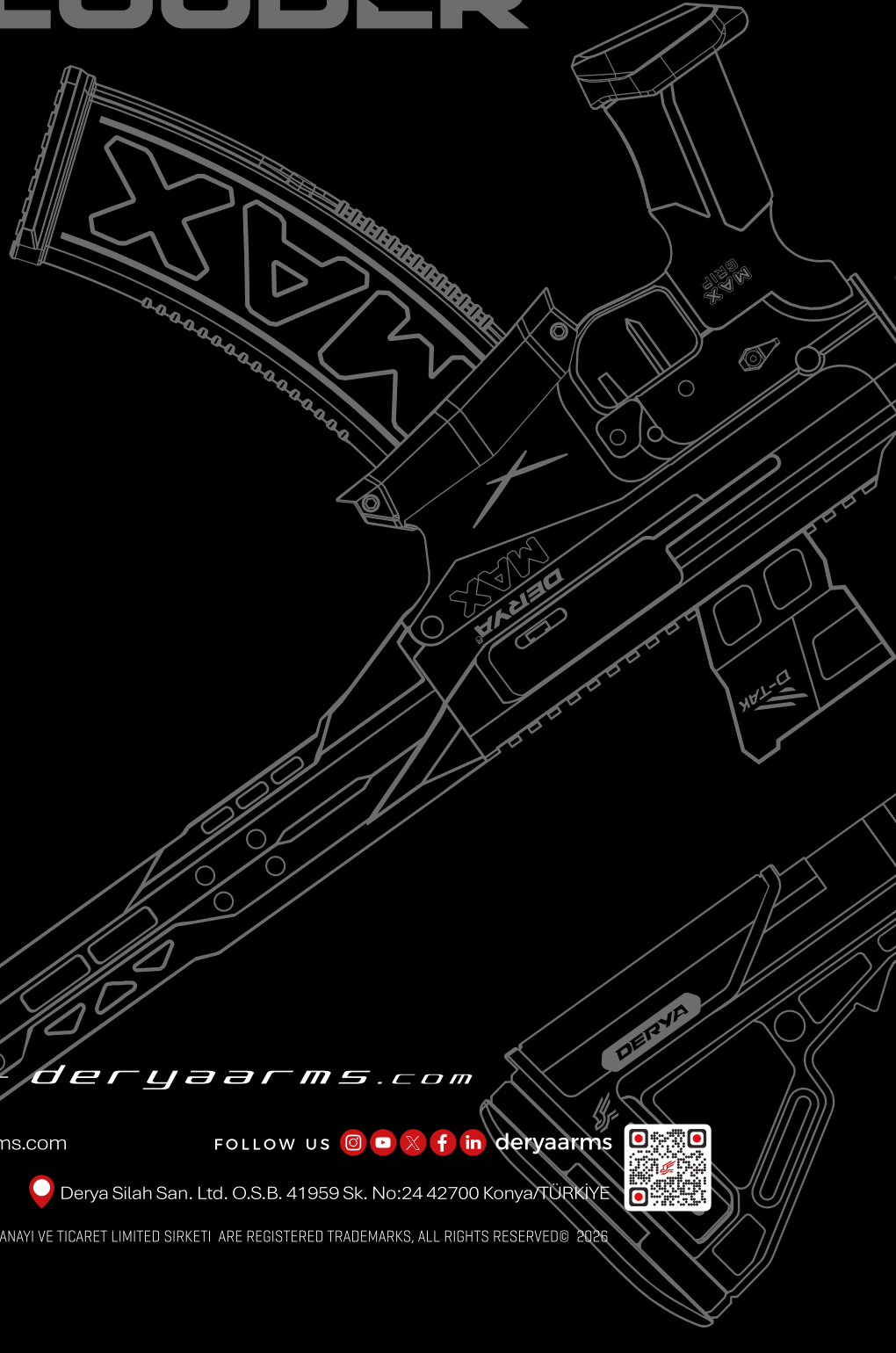

deryaarms.com

 support@deryaarms.com

FOLLOW US      [deryaarms](https://www.deryaarms.com)

 +90 (332) 514 8118

 Derya Silah San. Ltd. O.S.B. 41959 Sk. No:24 42700 Konya/TÜRKİYE



® DERYA SILAH SANAYİ VE TİCARET LİMİTED SİRKETİ ARE REGISTERED TRADEMARKS, ALL RIGHTS RESERVED © 2026